

FUME EXTRACTION

Price List - January 2008
FILCAR S.p.A.



Price List - January '08

Fume extraction systems

ARTICULATED ARMS	pag.	2
MOBILE UNITS FOR FUME EXTRACTION	pag.	4
MOBILE UNITS FOR FUME AND DUST EXTRACTION	pag.	6
FIX FILTRATION SYSTEMS	pag.	8
FANS AND ACCESSORIES	pag.	10
ALUMINIUM TRACKS SERIE CZ	pag.	12
ALUMINIUM TRACK SERIE XTK.....	pag.	15
FLEXIBLE HOSES AND ACCESSORIES	pag.	16
FUME EXTRACTION POSTS.....	pag.	18
FUME EXTRACTION AND FILTRATION POSTS.....	pag.	21
KIT FOR EXPULSION CHIMNEYS	pag.	22
COMPONENTS AND DUCTING	pag.	23
SALES CONDITIONS	pag.	29



TECHNO

Articulated arm with rigid aluminium pipes Ø 150 mm for welding fume extraction. Equipped with wall bracket.

Code	Description	Price €
TECHNO-220	Articulated arm Ø 150 - L. = 2 mt.	851,00
TECHNO-330	Articulated arm Ø 150 - L. = 3 mt.	870,00
TECHNO-420	Articulated arm Ø 150 - L. = 4 mt.	932,00
TECHNO-520	Articulated arm Ø 150 - L. = 5 mt.	1.043,00
TECHNO-620	Articulated arm Ø 150 - L. = 4 mt. + extension L. = 2 mt.	1.965,00
TECHNO-720	Articulated arm Ø 150 - L. = 4 mt. + extension L. = 3 mt.	2.033,00
TECHNO-820	Articulated arm Ø 150 - L. = 4 mt. + extension L. = 4 mt.	2.180,00
TECHNO-920	Articulated arm Ø 150 - L. = 4 mt + extension L. = 5 mt	2.406,00

Code	Spare parts	Price €
TECHNO-RIF1500	Flexible hose L. = 1500 - Ø 150 final junction (wall side)	42,00
TECHNO-RIF900	Flexible hose L. = 900 - Ø 150 central junctions	29,00
TECHNO-RIF830	Flexible hose L. = 830 - Ø 150 first junction (hood side)	29,00
CAPPETTA-150	Plastic hood for TECHNO	137,00

Code	Accessories	Price €
TECHNO-RALLA	Swivel for TECHNO	215,00
TECHNO-LIGHT	Light kit 24V 20W for TECHNO	446,00



TECHNOFLEX

Articulated arm with external flexible hose Ø 160 mm for welding fume extraction. Equipped with swivel for a 360° rotation.

Code	Description	Price €
TECHNOFLEX-220	Articulated arm Ø 160 - L. = 2 mt.	724,00
TECHNOFLEX-330	Articulated arm Ø 160 - L. = 3 mt.	737,00
TECHNOFLEX-420	Articulated arm Ø 160 - L. = 4 mt.	777,00
TECHNOFLEX-620	Articulated arm Ø 160 - L. = 4 mt. + extension L. = 2 mt.	1.809,00
TECHNOFLEX-720	Articulated arm Ø 160 - L. = 4 mt. + extension L. = 3 mt.	1.877,00
TECHNOFLEX-820	Articulated arm Ø 160 - L. = 4 mt. + extension L. = 4 mt.	2.024,00
TECHNOFLEX-920	Articulated arm Ø 160 - L. = 4 mt. + extension L. = 5 mt.	2.251,00

Code	Spare parts	Price €
TEC-FLEX-2	Flexible hose Ø 160 for TECHNOFLEX-220	78,00
TEC-FLEX-3	Flexible hose Ø 160 for TECHNOFLEX-330	109,00
TEC-FLEX-4	Flexible hose Ø 160 for TECHNOFLEX-420	140,00
CAPPETTA-160	Metal hood for TECHNOFLEX	158,00

Code	Accessories	Price €
TECHNO-RALLAFLEX	Swivel for TECHNOFLEX	215,00
TECHNOFLEX-LIGHT	Light kit 24V 20W for TECHNOFLEX	446,00

DUSTY (Ø 100 mm)		
Articulated arm with rigid aluminium pipes Ø 100 for welding fume extraction. Equipped with swivel for a 360° rotation.		
Code	Description	Price €
DUSTY-210	Articulated arm Ø 100 L = 2.1 mt.	839,00
DUSTY-270	Articulated arm Ø 100 L = 2.7 mt.	863,00
Code	Spare parts	Price €
DUSTYFLEX-300	Flexible hose L= 300 - Ø 100 - swivel side	25,00
DUSTYFLEX-500	Flexible hose L= 500 - Ø 100 - Hood junction and central junction	32,00
CAPPETTA-100	Aluminium hood for DUSTY-210 and DUSTY-270	168,00

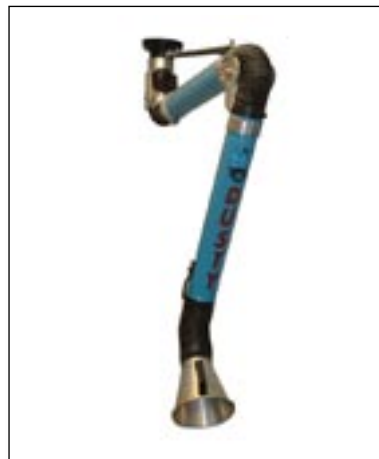

DUSTY (Ø 200 mm)		
Articulated arm with rigid aluminium pipes Ø 200 for welding fume extraction. Equipped with swivel for a 360° rotation.		
Code	Description	Price €
DUSTY-350	Articulated arm Ø 200 L = 3 mt.	1.336,00
DUSTY-470	Articulated arm Ø 200 L = 4 mt.	1.342,00
DUSTY-670	Articulated arm Ø 200 L = 4 mt. + extension L = 2 mt.	2.703,00
DUSTY-770	Articulated arm Ø 200 L = 4 mt. + extension L = 3 mt.	2.816,00
DUSTY-870	Articulated arm Ø 200 L = 4 mt. + extension L = 4 mt.	2.986,00
DUSTY-970	Articulated arm Ø 200 L = 4 mt. + extension L = 5 mt.	3.157,00
Code	Spare parts	Price €
DUSTYFLEX-450	Flexible hose L= 450 - Ø 200 - Junction (swivel side)	37,00
DUSTYFLEX-750	Flexible hose L= 750 - Ø 200 - Hood junction and central junction	48,00
CAPPETTA-200	Aluminium hood for DUSTY Ø 200	218,00



SPB		
Wall bracket for arms Ø 100, 150 and 200		
Code	Description	Price €
SPB-100	For articulated arms DUSTY Ø 100	102,00
SPB-150	For articulated arms TECHNOFLEX	119,00
SPB-200	For articulated arms DUSTY Ø 200	144,00



SSB		
Ceiling bracket for arms Ø 100, 150 and 200		
Code	Description	Price €
SSB-100	For articulated arms DUSTY Ø 100	202,00
SSB-150	For articulated arms TECHNOFLEX	227,00
SSB-200	For articulated arms DUSTY Ø 200	256,00





MINI90-NEW

Portable unit for welding fume extraction with hood and magnet.
Air flow 140 m³/h - Filtration efficiency 99% - 230V ~ 50/60HZ - 1150W

Code	Description	Price €
MINI90-NEW	Portable unit for welding fume complete with hose and hood	979,00
Code	Spare parts	Price €
MINI 90/RIC	Cartridge filter	168,00
MINI 90/TUBO	Flexible hose Ø 60 - L. = 3000 mm	36,00
MINI 90/CAPPE	Hood with magnetic support	72,00
MINI 90/CONT	Container with active carbon	50,00
MINI 90/RIS	Spare bag with 2 kg active carbon	18,00



ECOMINOR

Mobile unit for welding fume extraction with mechanical filtration. Complete with articulated arm TECHNO3/C. Fan 1,5HP and Air flow 1.400 m³/h. Description as below mentioned.

Code	Description	Price €
ECOMINOR	50Hz - 400V - 3phase (plug 3p+T) - 4,5kg active carbon	2.609,00
ECOMINOR-D	50Hz - 400V - 3phase (plug 3p+N+T) - 4,5kg active carbon	2.650,00
ECOMINOR-MONO	50Hz - 230V - 1phase (plug 1p+N+T) - 4,5kg active carbon	2.785,00
ECOMINOR-CARB	50Hz - 400V - 3phase (plug 3p+T) - 10kg active carbon	2.609,00
ECOMINOR2CARB	50Hz - 230V - 3phase (plug 3p+T) - 10kg active carbon	2.639,00
ECOMINOR-2	50Hz - 230V - 3phase (plug 3p+T) - 4,5kg active carbon	2.609,00
ECOMINOR-USA	60Hz - 208V - 3phase (plug 3p+T) - 4,5kg active carbon	2.952,00
ECOMINOR-M/CARB	50Hz - 230V - 1phase (plug 1p+N+T) - 10kg active carbon	2.785,00
Code	Spare parts	Price €
ECOMINOR/RIPM	FIREFILTER Metallic filter	37,00
ECOMINOR/RIPS	PREFILTER Synthetic filter	32,00
ECOMINOR/RIF	SMOKEFILTER High efficiency filter	70,00
ECOMINOR/CONT	CARBOFILTER Container complete with 4,5 Kg. active carbon	94,00
MINOR/CONT	CARBOFILTER Container complete with 10 Kg. active carbon	133,50
ECOMINOR/RIS	Spare bag with active carbon 4,5 Kg.	41,00
TECHNO3/C	Articulated arm L. = 3 mt. - Ø 150	870,00
TECHNO-RIF900	Flexible hose L. = 900 - Ø 150 central junctions	29,00
TECHNO-RIF830	Flexible hose L. = 830 - Ø 150 Hood junction and central junction	29,00
CAPPETTA-150	Plastic hood for TECHNO	137,00



ECOMINOR-C

Mobile unit for welding fume extraction with mechanical filtration, with 2 high efficiency cartridge filters. Complete with TECHNO3/C. Air flow 1.600 m³/h - Filtration efficiency 99,9%.

Code	Description	Price €
ECOMINOR-C	50Hz - 400V - 3phase (plug 3p+T)	2.949,00
ECOMINOR-CD	50Hz - 400V - 3phase (plug 3p+N+T)	2.949,00
ECOMINOR-CM	50Hz - 230V - 1phase (plug 1p+N+T)	3.125,00
Code	Spare parts	Price €
ECOMINOR/RIPM	FIREFILTER Metallic filter	37,00
ECOMINOR/CART	Cellulose cartridge filter U. S. G. BIA	cad. 227,00
ECOMINOR/CART C	Cartridge filter polyester aluminium coated U.S.G.C.BIA	cad. 325,00
TECHNO3/C	Articulated arm L. = 3 mt. - Ø 150	870,00
TECHNO-RIF900	Flexible hose L. = 900 - Ø 150 central junctions	29,00
TECHNO-RIF830	Flexible hose L. = 830 - Ø 150 Hood junction and central junction	29,00
CAPPETTA-150	Plastic hood for TECHNO	137,00

MASTER-1BR		
Mobile unit for welding fume extraction with mechanical filtration. Complete with articulated arm TECHNO3/C. Air flow 1.500 m ³ /h - Filtration efficiency 99% - 2,2kW/3HP		
Code	Description	Price €
MASTER-1BR	50Hz - 400V - 3phase (plug 3p+T)	3.720,00
MASTER-1BR/D	50Hz - 400V - 3phase (plug 3p+N+T)	3.761,00
MASTER-1BR/220	50Hz - 230V - 3phase (plug 3p+T)	3.720,00
Code	Spare parts	Price €
MASTER/RIPM	FIREFILTER Metallic filter	72,00
MASTER/RIPS	PREFILTER Synthetic filter	48,00
MASTER/RIF	SMOKEFILTER High efficiency filter	411,00
MASTER/CONT	CARBOFILTER Container complete with 16 Kg. active carbon	261,00
MASTER/RIS	Spare bag with active carbon 16 Kg.	146,00
TECHNO3/C	Articulated arm L. = 3 mt. - Ø 150	870,00
TECHNO-RIF900	Flexible hose L. = 900 - Ø 150 central junctions	29,00
TECHNO-RIF830	Flexible hose L. = 830 - Ø 150 Hood junction and central junction	29,00
CAPPETTA-150	Plastic hood for TECHNO	137,00



MASTER-200		
Mobile unit for welding fume extraction with mechanical filtration. Complete with articulated arm DUSTY-350/C. Air flow 2.000 m ³ /h - Filtration efficiency 99% - 2,2kW/3HP		
Code	Description	Price €
MASTER-200	50Hz - 400V - 3phase (plug 3p+T)	4.423,00
Code	Spare parts	Price €
MASTER/RIPM	FIREFILTER Metallic filter	72,00
MASTER/RIPS	PREFILTER Synthetic filter	48,00
MASTER/RIF	SMOKEFILTER High efficiency filter	411,00
MASTER/CONT	CARBOFILTER Container complete with 16 Kg. active carbon	261,00
MASTER/RIS	Spare bag with active carbon 16 Kg.	146,00
DUSTY-350/C	Articulated arm L. = 3 mt. - Ø 200	1.336,00
DUSTYFLEX-750	Flexible hose L. = 750 - Ø 200 - Hood junction and central junction	48,00
DUSTYFLEX-450	Flexible hose L. = 450 - Ø 200 - Junction (swivel side)	37,00
CAPPETTA-200	Aluminium hood for DUSTY Ø 200	218,00



MASTER-2BR		
Mobile unit for welding fume extraction with mechanical filtration. Complete with TWO articulated arms TECHNO 3/C. Air flow 2.000 m ³ /h - Filtration efficiency 99% - 2,2kW/3HP		
Code	Description	Price €
MASTER-2BR	50Hz - 400V - 3phase (plug 3p+T)	4.906,00
Code	Spare parts	Price €
MASTER/RIPM	FIREFILTER Metallic filter	72,00
MASTER/RIPS	PREFILTER Synthetic filter	48,00
MASTER/RIF	SMOKEFILTER High efficiency filter	411,00
MASTER/CONT	CARBOFILTER Container complete with 16 Kg. active carbon	261,00
MASTER/RIS	Spare bag with active carbon 16 Kg.	146,00
TECHNO3/C	Articulated arm L. = 3 mt. - Ø 150	870,00
TECHNO-RIF900	Flexible hose L. = 900 - Ø 150 central junctions	29,00
TECHNO-RIF830	Flexible hose L. = 830 - Ø 150 Hood junction and central junction	29,00
CAPPETTA-150	Plastic hood for TECHNO	137,00





MINIJET-2

Mobile unit for welding fume extraction and dust with mechanical filtration, with long lasting polyester U. S. G. C. BIA cartridge filter, compressed air cleaning system. Complete with articulated arm TECHNO3/C. Air flow 1.350 m³/h - Filtration efficiency 99.9% - 1,5kW/2HP

Code	Description	Price €
MINIJET-2	50Hz - 400V - 3phase (plug 3p+T)	4.968,00
Code	Spare parts	Price €
MINIJET/CART-USGC	Long lasting cartridge filter, in polyester 270 g/m ² U. S. G. C. BIA	465,00
TECHNO3/C	Articulated arm L. = 3 mt. - Ø 150	870,00
TECHNO-RIF900	Flexible hose L. = 900 - Ø 150 central junctions	29,00
TECHNO-RIF830	Flexible hose L. = 830 - Ø 150 Hood junction and central junction	29,00
CAPPETTA-150	Plastic hood for TECHNO	137,00



MASTERJET-1BR

Mobile unit for welding fume extraction and dust with mechanical filtration, with 2 polyester cartridge filters U. S. G. C. BIA long lasting, compressed air cleaning system. Complete with articulated arm TECHNO3/C. Air flow 1.500 m³/h - Filtration efficiency 99.9% - 2,2kW/3HP

Code	Description	Price €
MASTERJET-1BR	50Hz - 400V - 3phase (plug 3p+T)	6.521,00
Code	Spare parts	Price €
MASTERJETCA1	Polyester cartridge filter U. S. G. C. BIA Ø 325 - H. 500	375,00
TECHNO3/C	Articulated arm L. = 3 mt. - Ø 150	870,00
TECHNO-RIF900	Flexible hose L. = 900 - Ø 150 central junctions	29,00
TECHNO-RIF830	Flexible hose L. = 830 - Ø 150 Hood junction and central junction	29,00
CAPPETTA-150	Plastic hood for TECHNO	137,00

MASTER JET-2BR		
Mobile unit for welding fume and dust extraction with mechanical filtration, with 2 polyester cartridge filters U. S. G. C. BIA long lasting, compressed air cleaning system. Complete with two articulated arms TECHNO3/C. Air flow 2.400 m ³ /h - Filtration efficiency 99.9% - 2,2kW/3HP		
Code	Description	Price €
MASTERJET-2BR	50Hz - 400V - 3phase (plug 3p+T)	7.265,00
Code	Spare parts	Price €
MASTERJETCA1	Polyester cartridge filter U. S. G. C. BIA Ø 325 - H. 500	375,00
TECHNO3/C	Articulated arm L. = 3 mt. - Ø 150	870,00
TECHNO-RIF900	Flexible hose L. = 900 - Ø 150 central junctions	29,00
TECHNO-RIF830	Flexible hose L. = 830 - Ø 150 Hood junction and central junction	29,00
CAPPETTA-150	Plastic hood for TECHNO	137,00



MASTER JET-200		
Mobile unit for welding fume and dust extraction with mechanical filtration, with 2 polyester cartridge filters U. S. G. C. BIA long lasting, compressed air cleaning system. Complete with articulated arm DUSTY-350/C. Air flow 2.000 m ³ /h - Filtration efficiency 99.9% - 2,2kW/3HP		
Code	Description	Price €
MASTERJET-200	50Hz - 400V - 3phase (plug 3p+T)	6.930,00
Code	Spare parts	Price €
MASTERJETCA1	Polyester cartridge filter U. S. G. C. BIA Ø 325 - H. 500	375,00
DUSTY-350/C	Articulated arm L. = 3 mt. - Ø 200	1.336,00
DUSTYFLEX-450	Flexible hose L. = 450 - Ø 200 - Junction (swivel side)	48,00
DUSTYFLEX-750	Flexible hose L. = 750 - Ø 200 - Hood junction and central junction	37,00
CAPPETTA-200	Aluminium hood for DUSTY-350/C	218,00





STAR-2000		
Mechanical filter - Air flow 2.000 m ³ /h - Inlet (left side) Ø 200/R		
Code	Description	Price €
STAR-2000	Mechanical filter for welding fume up to 2.000 m ³ /h	1.248,50
Code	Spare parts	Price €
STAR2000-RIPM	FIREFILTER Metallic filter	37,00
STAR2000-RIPS	PREFILTER Synthetic filter	31,50
STAR-2000-RIF	SMOKEFILTER High efficiency filter	275,50
STAR2000-CONT	CARBONFILTER Container complete with 10 Kg. active carbon	133,50
STAR-2000-RIS	Spare bag with active carbon 10 Kg.	84,00
Code	Accessories	Price €
STAR-2000-FU	Outlet flange Ø 200/R for filtered fume discharge	147,00
STAR-2000-SPS	2 Special wall brackets	55,00



STAR-4000		
Mechanical filter - Air flow 4000 m ³ /h - Inlet (left side) Ø 200/R		
Code	Description	Price €
STAR-4000	Mechanical filter for welding fume up to 4.000 m ³ /h	1.767,50
Code	Spare parts	Price €
STAR4000-RIPM	FIREFILTER Metallic filter	70,50
STAR4000-RIPS	PREFILTER Synthetic filter	47,50
STAR-4000-RIF	SMOKEFILTER High efficiency filter	403,50
STAR4000-CONT	CARBONFILTER Container complete with 16 Kg. active carbon	256,50
STAR-4000-RIS	Spare bag with active carbon 16 Kg.	143,00
Code	Accessories	Price €
STAR-4000-FU	Outlet flange Ø 200/R for filtered fume discharge	203,00
STAR-4000-SPS	2 Special wall brackets	62,00

FILTER		
Modular filtering unit with pocket filters		
Code	Description	Price €
FILTER-21	Air flow 1.500 m ³ /h - dim. 700 x 350 - peso lordo 25 Kg. (1 x PF-287 - 1 x FIT-287)	690,00
FILTER-22	Air flow 3.000 m ³ /h - dim. 700 x 700 - peso lordo 42 Kg. (1 x PF-590 - 1 x FIT-590)	813,00
FILTER-32	Air flow 4.500 m ³ /h - dim. 1050 x 700 - peso lordo 67 Kg. (1 x PF-287 - 1 x FIT-287 - 1X PF-590 - 1 x FIT-590)	1.509,00
FILTER-42	Air flow 6.000 m ³ /h - dim. 1400 x 700 - peso lordo 84 Kg. (2 x PF-590 - 2 x FIT-590)	1.645,00
FILTER-62	Air flow 9.000 m ³ /h - dim. 2100 x 700 - peso lordo 126 Kg. (3 x PF-590 - 3 x FIT-590)	2.609,00
FILTER-44	Air flow 12.000 m ³ /h - dim. 1400 x 1400 - peso lordo 168 Kg. (4 x PF-590 - 4 x FIT-590)	3.277,00
FILTER-54	Air flow 15.000 m ³ /h - dim. 1750 x 1400 - peso lordo 218 Kg. (2 x PF-287 - 2 x FIT-287 - 4 x PF-590 - 4 x FIT-590)	4.877,00
FILTER-64	Air flow 18.000 m ³ /h - dim. 2100 x 1400 - peso lordo 252 Kg. (6 x PF-590 - 6 x FIT-590)	5.297,00
Code	Spare parts	Price €
PF-287	prefiltro for FILTER 700 x 350	65,00
PF-590	prefiltro for FILTER 700 x 700	86,00
FIT-287	High efficiency filter for FILTER 700 x 350	143,00
FIT-590	High efficiency filter for FILTER 700 x 700	218,00

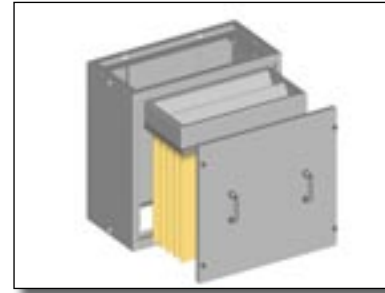

CARBON		
Modular deodorizing unit with active carbon		
Code	Description	Price €
CARBON-21	Air flow 1.500 m ³ /h - c.a. 20 Kg. - dim. 700 x 350. 48 Kg.	1.517,50
CARBON-22	Air flow 3.000 m ³ /h - c.a. 40 Kg. - dim. 700 x 700. 88 Kg.	2.613,50
CARBON-42	Air flow 6.000 m ³ /h - c.a. 80 Kg. - dim. 1400 x 700. 166 Kg.	4.968,00
CARBON-62	Air flow 9.000 m ³ /h - c.a. 120 Kg. - dim. 2100 x 700. 264 Kg.	7.389,00
CARBON-44	Air flow 12.000 m ³ /h - c.a. 160 Kg. - dim. 1400 x 1400. 352 Kg.	9.936,00
CARBON-54	Air flow 15.000 m ³ /h - c.a. 200 Kg. - dim. 1750 x 1400. 448 Kg.	12.822,00
CARBON-64	Air flow 18.000 m ³ /h - c.a. 240 Kg. - dim. 2100 x 1400. 528 Kg.	14.717,00
Code	Spare parts	Price €
CARBON-CARTU	Spare plastic cartridge without carbons	47,50
CARBON-RIS	Spare bag with active carbon 10 Kg.	89,50



Accessories		
Inlet / outlet flange for FILTER or CARBON		
Code	Description	Price €
FEU-150	per FILTER or CARBON21	272,00
FEU-300	per FILTER or CARBON22	280,00
FEU-450	per FILTER or CARBON32	380,00
FEU-600	per FILTER or CARBON42	560,00
FEU-900	per FILTER or CARBON62	784,00
FEU-1200	per FILTER or CARBON44	1.260,00
FEU-1500	per FILTER or CARBON54	1.400,00
FEU-1800	per FILTER or CARBON64	1.520,00
Please specify the outlet / inlet diameter		



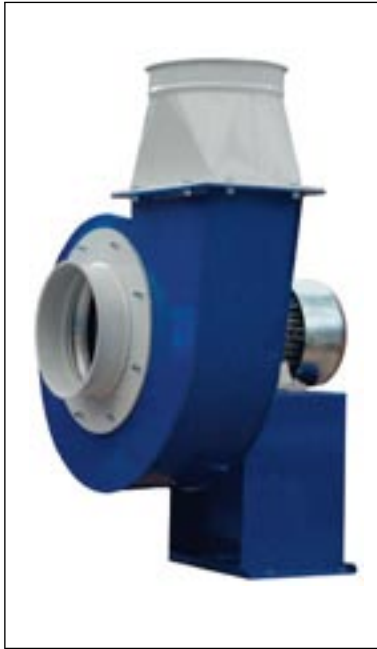

AL		
Steel sheet centrifugal fans complete with support, inlet and outlet flanges		
Code	Description	Price €
AL-50/C	Q. max 900 m ³ /h – press. max 105 mm. H20 230/400V ~3phase - 50HZ - 0,37kW/0,5HP - in/out Ø 150-R	605,00
AL-100/C	Q. max 1700 m ³ /h – press. max 95 mm. H20 230/400V ~3phase - 50HZ - 0,75kW/HP1 - in/out Ø 180-R	794,00
AL-150/C	Q. max 2100 m ³ /h – press. max 145 mm. H20 230/400V ~3phase - 50HZ - 1,1kW/1,5HP - in/out Ø 180-R	841,50
AL-200/C	Q. max 3000 m ³ /h – press. max 165 mm. H20 230/400V ~3phase - 50HZ - 1,5kW /2HP - in/out Ø 200-R	890,50
AL-300/C	Q. max 4100 m ³ /h – press. max 164 mm. H20 230/400V ~3phase - 50HZ - 2,2kW /3HP - in/out Ø 200-R	1.097,50
AL-400/C	Q. max 6150 m ³ /h – press. max 242 mm. H20 230/400V ~3phase - 50HZ - 3kW/4HP - in/out Ø 220-R	1.622,00
AL-550/C	Q. max 6150 m ³ /h – press. max 277 mm. H20 230/400V ~3phase - 50HZ - 4kW/5,5HP - in/out Ø 250-R	1.740,00
AL-750/C	Q. max 8500 m ³ /h – press. max 305 mm. H20 380/690V ~3phase - 50HZ - 5,5kW /7,5HP - in/out Ø 300-R	2.270,00
AL-1000/C	Q. max 8500 m ³ /h – press. max 350 mm. H20 380/690V ~3phase - 50HZ - 7,5kW /10HP - in/out Ø 350-R	2.501,00
AL-1500/C	Q. max 12000 m ³ /h – press. max 392 mm. H20 380/690V ~3phase - 50HZ - 11kW/15HP - in/out Ø 380-R	2.925,50
AL-2000/C	Q. max 12000 m ³ /h – press. max 448 mm. H20 380/690V ~3phase - 50HZ - 15kW/20HP - in/out Ø 400-R	4.356,50



CV		
Stand		
Code	Description	Price €
CV-50-300	For fans from 0,5 to 3 HP	104,00
CV-400-550	For fans from 4 to 5,5 HP	214,50
CV-750-1000	For fans from 7,5 to 10 HP	298,50
CV-1500-2000	For fans from 15 to 20 HP	298,50



SET-PIEDINI		
Vibration suppressing feet		
Code	Description	Price €
SET-PIEDINI/P	For fans up to 1,5 HP (4 pieces)	61,00
SET-PIEDINI/M	For fans from 2 to 3 HP (4 pieces)	61,00
SET-PIEDINI/G	For fans from 4 to 20 HP (4 pieces)	61,00



ME		
Wall bracket		
Code	Description	Price €
ME-50-300	For fans from 0,5 a 3 HP.	133,50
ME-400/500	For fans from 4 a 5,5 HP.	335,00
ME-750/1000	For fans from 7,5 a 10 HP.	489,50



CM		
Motor cover for fans series AL		
Code	Description	Price €
CM-0.5-0.75	For fans from 0,5 to 0,75 HP	71,50
CM-1-1.5	For fans from 1 to 1,5 HP	76,00
CM-2-3	For fans from 2 to 3 HP	82,00
CM-4-5.5	For fans from 4 to 5,5 HP	141,00
CM-7.5-10	For fans from 7,5 to 10 HP	141,00
CM-15-20	For fans from 15 to 20 HP	146

BOX-INS		
Sound proof box for fans serie AL		
Code	Description	Price €
BOX-AL100/150	For fans AL-100/C and AL-150/C	1.230,00
BOX-AL200/300	For fans AL-200/C and AL-300/C	1.400,00
BOX-AL400	For fan AL-400/C	1.670,00
BOX-AL550	For fan AL-550/C	1.725,00
BOX-AL750	For fan AL-750/C	1.825,00
BOX-AL1000	For fan AL-1000/C	1.890,00



QE-AC		
Switchboard for centralized fan with predisposition for a remoted switch		
Code	Description	Price €
QE-AC 1/1.0	1 HP - 0,75 kW - 400 V - 3phase direct start	504,00
QE-AC 1/1.5	1,5 HP - 1,1 kW - 400 V - 3phase direct start	504,00
QE-AC 1/2.0	2 HP - 1,5 kW - 400 V - 3phase direct start	504,00
QE-AC 1/3.0	3 HP - 2,2 kW - 400 V - 3phase direct start	504,00
QE-AC 1/4.0	4 HP - 3 kW - 400 V - 3phase direct start	504,00
QE-AC 1/5.5	5,5 HP - 4 kW - 400 V - 3phase direct start	504,00
QE-AC 2/5.5	5,5 HP - 4 kW - 400 V - 3phase delta star switch	974,50
QE-AC 2/7.5	7,5 HP - 5 kW - 400 V - 3phase delta star switch	974,50
QE-AC 2/10	10 HP - 7,5 kW - 400 V - 3phase delta star switch	974,50
QE-AC 2/15	15 HP - 11 kW - 400 V - 3phase delta star switch	999,00
QE-AC 2/20	20 HP - 15 kW - 400 V - 3phase delta star switch	1.048,00



INT		
Simple switch with termical protection and with connection cable (70 cm)		
Code	Description	Price €
INT. 0,6-1,0 A/CC	0,6-1 A - 0,25 kW - 0,35 HP	103,00
INT. 1,0-1,6 A/CC	1-1,6 A - 0,37 kW - 0,5HP	103,00
INT. 1,6-2,5 A/CC	1,6-2,5 A - 0,75 kW - 1HP	103,00
INT. 2,5-4,0 A/CC	2,5-4 A - 1,1/1,5 kW - 1,5/2HP	103,00
INT. 4,0-6,3 A/CC	4-6,3 A - 2,2 kW - 3HP	103,00
INT. 6,3-10 A/CC	6,3-10 A - 3/4 kW - 4/5,5HP	103,00
INT. 9,0-14 A/CC	9-14 A - 5,5/7,5 kW - 7,5/10HP	103,00





CZ		
Aluminium track for sliding extraction systems. Ø 195 mm. Max Air flow 2.350 m ³ /h		
Code	Description	Price €
CZ-3000	Module 3 mt. long	604,00
CZ-6000	Module 6 mt. long	1.206,50
Code	Spare parts	Price €
GN-120X3	Black rubber lip in 10 mt. roll (price per meter)	€/m 7,50
NTN-38X2,75	Black tissue tape for rubber lip connection 2,75 mt. long	8,50

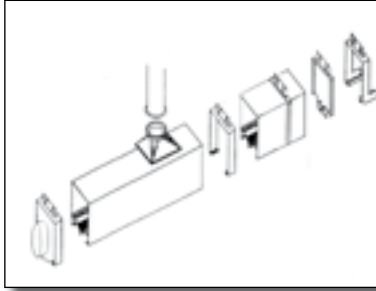

COMPONENTS FOR CZ		
Flanges and components for track series CZ		
Code	Description	Price €
STZ	Support flange	29,50
STZ-R	Reinforced support flange	45,50
STGZ	Jointing and supporting flange	40,00
STGZ-R	Reinforced jointing and supporting flange	51,50
S-FZ	Jointing band	30,50
FUSZ	Upper outlet flange Ø 180-R	108,50
FULZ	Lateral outlet flange Ø 180-R	144,00
FUZ-STZ	Terminal outlet flange Ø 200-R complete with holes for bracket	123,00
FCZ-STZ	Terminal closing flange complete with holes for bracket	75,00



CZ-1		
Aluminium track for sliding extraction systems. Ø 248 mm. Max Air flow 3.800 m ³ /h		
Code	Description	Price €
CZ1-2000	Module 2 mt. long	487,50
CZ1-4000	Module 4 mt. long	945,00
CZ1-6000	Module 6 mt. long	1371,50
Code	Spare parts	Price €
GN-120X3	Black rubber lip in 10 mt. roll (price per meter)	7,50
NTN-38X2,75	Black tissue tape for rubber lip connection 2,75 mt. long	8,50

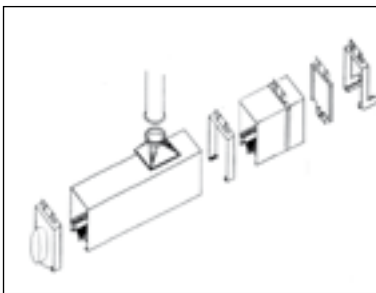

COMPONENTS FOR CZ-1		
Flanges and components for track series CZ-1		
Code	Description	Price €
STZ-1	Support flange	34,00
STZ-1-R	Reinforced support flange	47,50
STGZ-1	Jointing and supporting flange	40,00
STGZ-1-R	Reinforced jointing and supporting flange	50,50
S-FZ1	Jointing band	37,00
FUSZ-1	Upper outlet flange Ø 200-R	131,50
FULZ-1	Lateral outlet flange Ø 200-R	152,50
FUZ-1-STZ-1	Terminal outlet flange Ø 200-R complete with holes for bracket	141,00
FCZ-1-STZ-1	Terminal closing flange complete with holes for bracket	91,50

CZ-2		
Aluminium track for sliding extraction systems. Ø 334 mm. Max Air flow 6.900 m³/h		
Code	Description	Price €
CZ2-2000	Module 2 mt. long	572,00
CZ2-4000	Module 4 mt. long	1.030,50
CZ2-6000	Module 6 mt. long	1.533,50
Code	Spare parts	Price €
GN-120X3	Black rubber lip in 10 mt. roll (price per meter)	7,50
NTN-38X2,75	Black tissue tape for rubber lip connection 2,75 mt. long	8,50



ACCESSORIES FOR CZ-2		
Flanges and components for track series CZ-2		
Code	Description	Price €
STZ-2	Support flange	
STZ-2-R	Reinforced support flange	
STGZ-2	Jointing and supporting flange	50,50
STGZ-2-R	Reinforced jointing and supporting flange	67,50
S-FZ2	Jointing band	58,00
FUSZ-2	Upper outlet flange Ø 350-R	168,00
FULZ-2	Lateral outlet flange Ø 350-R	248,00
FUZ-2	Terminal outlet flange Ø 350-R	149,00
FCZ-2	Terminal closing flange	69,50

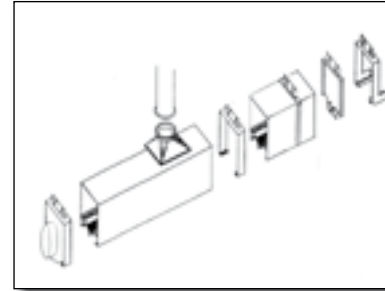

CZ-3		
Aluminium track for sliding extraction systems. Ø 472 mm. Max Air flow 13.850 m³/h		
Code	Description	Price €
CZ3-2000	Module 2 mt. long	839,00
CZ3-4000	Module 4 mt. long	1.553,00
CZ3-6000	Module 6 mt. long	2.235,00
Code	Spare parts	Price €
GN-120X3	Black rubber lip in 10 mt. roll (price per meter)	7,50
NTN-38X2,75	Black tissue tape for rubber lip connection 2,75 mt. long	8,50



ACCESSORIES FOR CZ-3		
Flanges and components for track series CZ-3		
Code	Description	Price €
STGZ-3	Jointing and supporting flange	83,50
FUSZ-3	Upper outlet flange Ø 350-R	237,50
FUZ-3	Terminal outlet flange Ø 500-R	236,50
FCZ-3	Terminal closing flange	107,00

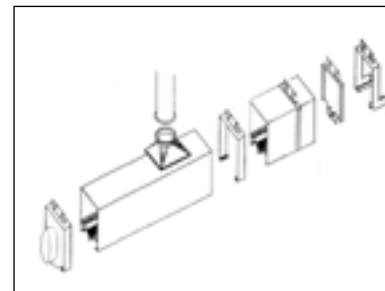



SLIDING ELEMENTS FOR ALUMINIUM TRACK SERIES CZ

Sliding carriages for aluminium track series CZ

Code	Description	Price €
CSZT-75+ASZT	Carriage for hose Ø 75	365,50
CSZT-100+ASZT	Carriage for hose Ø 100	365,50
CSZT-125+ASZT	Carriage for hose Ø 125	366,50
CSZT-150+ASZT	Carriage for hose Ø 150	366,50
CSZT-180+ASZT	Carriage for hose Ø 180	497,00
CSZT-200+ASZT	Carriage for hose Ø 200	497,00
CSZB-100	Carriage for articulated arm series DUSTY Ø 100	354,00
CSZB-150	Carriage for articulated arm series TECHNOFLEX	335,00
CSZB-200	Carriage for articulated arm series DUSTY Ø 200	458,00
Code	Accessories	Price €
BLS-SUP75-10	Support for balancer suitable for sliding carriages CSZT Ø 75 - Ø 100	61,00
BLS-SUP12-15	Support for balancer suitable for sliding carriages CSZT Ø 125 - Ø 150	61,00
BL-A	Balancer with counter release and nylon cable suitable up to 10 Kg.	556,50



SLIDING ELEMENTS FOR ALUMINIUM TRACK SERIES XTK

Sliding carriages

Code	Description	Price €
CSZT-75EASZT	Carriage for hose Ø 75	349,00
CSZT-100EASZT	Carriage for hose Ø 100	349,00
CSZT-125EASZT	Carriage for hose Ø 125	366,50
CSZT-150EASZT	Carriage for hose Ø 150	366,50
CSZT-180EASZT	Carriage for hose Ø 180	445,00
CSZT-200EASZT	Carriage for hose Ø 200	446,00
Code	Description	Price €
CSZB-150-XTK	Sliding carriage for arms series TECHNOFLEX	361,00
Code	Accessories	Price €
BLS-SUP75-10E	Support for balancer suitable for sliding carriages CSZT Ø 75-100	61,00
BLS-SUP12-15E	Support for balancer suitable for sliding carriages CSZT Ø 125-150	61,00
BLS-SUP200E	Support for balancer suitable for sliding carriages CSZB 200-XTK Ø 125-150	61,00
BL-A	Balancer with counter release and nylon cable suitable up to 10 kg.	556,50

XTK-1		
Extruded aluminium track with Ø 170 mm. Max Air flow 1.800 m ³ /h		
Code	Description	Price €
XTK1-2000	Module 2 mt. long	501,00
XTK1-3000	Module 3 mt. long	723,50
XTK1-4000	Module 4 mt. long	946,50
XTK1-6000	Module 6 mt. long	1.391,50
Code	Spare parts	Price €
GN-95X3	Black rubber lip in 10 mt. roll (price per meter)	7,50
NTN-38X2,75	Black tissue tape for rubber lip connection 2,75 mt. long	8,50



ACCESSORIES FOR XTK-1		
Brackets and flanges		
Code	Description	Price €
XTK-KST	Universal sliding support	42,00
XTK-FUS-150L	Upper outlet flange Ø 150-L	189,00
XTK-FUS-180L	Upper outlet flange Ø 180-L	212,50
XTK-FUS-200L	Upper outlet flange Ø 200-L	212,50
XTK1-FUA-150L	Terminal outlet flange Ø 150-L	92,50
XTK1-FSG	Jointing band	58,00
XTK1-FDC	Terminal closing flange	39,00
XTK-KFA	Universal fixing kit for AL-200/300 onto aluminium track	131,00
XTK-KFA/P	Universal fixing kit for AL-100/150 onto aluminium track	129,00
XTK-KFA/G	Universal fixing kit for AL-400 onto aluminium track	145,50



XTK-2		
Extruded aluminium track with Ø 210 mm. Max Air flow 2.750 m ³ /h		
Code	Description	Price €
XTK2-2000	Module 2 mt. long	612,50
XTK2-3000	Module 3 mt. long	768,00
XTK2-4000	Module 4 mt. long	1.069,00
XTK2-6000	Module 6 mt. long	1.536,50
Code	Spare parts	Price €
GN-95X3	Black rubber lip in 10 mt. roll (price per meter)	7,50
NTN-38X2,75	Black tissue tape for rubber lip connection 2,75 mt. long	8,50



ACCESSORIES FOR XTK-2		
Brackets and flanges		
Code	Description	Price €
XTK-KST	Universal sliding support	42,00
XTK-FUS-150L	Upper outlet flange Ø 150-L	189,00
XTK-FUS-180L	Upper outlet flange Ø 180-L	212,50
XTK-FUS-200L	Upper outlet flange Ø 200-L	212,50
XTK2-FUA-150L	Terminal outlet flange Ø 150-L	92,50
XTK2-FUA-180L	Terminal outlet flange Ø 180-L	92,50
XTK2-FSG	Jointing band	58,00
XTK2-FDC	Terminal closing flange	39,00
XTK-KFA	Universal fixing kit for AL-200/300 onto aluminium track	131,00
XTK-KFA/P	Universal fixing kit for AL-100/150 onto aluminium track	129,00
XTK-KFA/G	Universal fixing kit for AL-400 onto aluminium track	145,50





ALLUFLEX

Seamed aluminium flexible hose Fire-proof. Max. temp. 300°C. Extensible from 1 to 3 mt.

Code	Description	Price €
ALLUFLEX-100	Ø 100 – estensibile fino a 3 mt.	26,50
ALLUFLEX-120	Ø 120 – estensibile fino a 3 mt.	28,50
ALLUFLEX-150	Ø 150 – estensibile fino a 3 mt.	34,00
ALLUFLEX-180	Ø 180 – estensibile fino a 3 mt.	37,00
ALLUFLEX-200	Ø 200 – estensibile fino a 3 mt.	43,50



ASPIRFLEX

Glass fabric hose coated with PVC strengthened with harmonic steel close coil. Operating temperature -20°C + 110°C. Max roll lenght 10 mt. Suitable for junctions and covering.

Code	Description	Price €
ASPIRFLEX-100	Ø 100 – 1 mt. extensible up to 3 mt.	19,00
ASPIRFLEX-120	Ø 120 – 1 mt. extensible up to 3 mt.	22,50
ASPIRFLEX-150	Ø 150 – 1 mt. extensible up to 3 mt.	27,50
ASPIRFLEX-180	Ø 180 – 1 mt. extensible up to 3 mt.	30,50
ASPIRFLEX-200	Ø 200 – 1 mt. extensible up to 3 mt.	34,00
ASPIRFLEX-220	Ø 220 – 1 mt. extensible up to 3 mt.	37,00
ASPIRFLEX-250	Ø 250 – 1 mt. extensible up to 3 mt.	40,00



EUROGAS

Crush-proof nylon coil black reinforced flexible hose for max. temperature of 200°C (392°F). Suitable for fitting on reels and for sliding systems or floor-mounted systems. Strongly recommended for its great flexibility, lightness and resistance.

Code	Description	Price €
EUROGA100/2.5	Ø 100 - 2,5 mt.	167,00
EUROGAS-100/5	Ø 100 - 5 mt.	334,00
EUROGA100/7.5	Ø 100 - 7,5 mt.	501,00
EUROGAS100/10	Ø 100 - 10 mt.	668,00
EUROGAS-125/5	Ø 125 - 5 mt.	367,50
EUROGA125/7.5	Ø 125 - 7,5 mt.	551,50
EUROGAS125/10	Ø 125 - 10 mt.	735,00
EUROGAS150/5	Ø 150 - 5 mt.	479,00
EUROGA150/7.5	Ø 150 - 7,5 mt.	718,50
EUROGAS150/10	Ø 150 - 10 mt.	958,00
EUROGAS150/20	Ø 150 - 20 mt.	1.914,50
EUROGAS180/10	Ø 180 - 10 mt.	1.146,00
EUROGAS180/20	Ø 180 - 20 mt.	2.290,50
EUROGAS200/10	Ø 200 - 10 mt.	1.280,00
EUROGAS200/20	Ø 200 - 20 mt.	2.560,00



HOSE STORAGE

Wall bearing for hose storage

Code	Description	Price €
ECOARGON/SM	Wall bearing for hoses Ø 75 mm (3") and Ø 100 mm (4") mm	41,00
Code	Description	Price €
SM-20	Ergonomic wall bearing for hoses Ø 75 mm (3") and Ø 100 mm (4") mm	76,00
SM-30	Ergonomic universal wall bearing for inactive hoses from Ø 75 mm (3") up to Ø 150 mm (6") mm with storage for nozzle	105,00

ATR/B		
Quick coupling for flexible hoses		
Code	Description	Price €
ATR/B-75	Bayonet quick coupling for hoses Ø 75 mm (3")	64,50
ATR/B-100	Bayonet quick coupling for hoses Ø 100 mm (4")	64,50
ATR/B-125	Bayonet quick coupling for hoses Ø 125 mm (5")	64,50
ATR/B-150	Bayonet quick coupling for hoses Ø 150 mm (6")	64,50
ATR/B-200	Bayonet quick coupling for hoses Ø 200 mm (8")	64,50



TE		
Sheet metal coupling for flexible hoses		
Code	Description	Price €
TE-75	Sheet metal coupling for flexible hoses Ø 75 mm (3")	19,00
TE-100	Sheet metal coupling for flexible hoses Ø 100 mm (4")	21,00
TE-125	Sheet metal coupling for flexible hoses Ø 125 mm (5")	26,50
TE-150	Sheet metal coupling for flexible hoses Ø 150 mm (6")	28,50
TE-180	Sheet metal coupling for flexible hoses Ø 180 mm (7")	30,50
TE-200	Sheet metal coupling for flexible hoses Ø 200 mm (8")	34,00



FSC		
Metallic clamp for flexible hoses		
Code	Description	Price €
FSC-75	Metallic clamp for flexible hoses Ø 75 mm (3")	3,50
FSC-100	Metallic clamp for flexible hoses Ø 100 mm (4")	3,50
FSC-120	Metallic clamp for flexible hoses Ø 120 mm	4,50
FSC-125	Metallic clamp for flexible hoses Ø 125 mm (5")	4,50
FSC-150	Metallic clamp for flexible hoses Ø 150 mm (6")	4,50
FSC-180	Metallic clamp for flexible hoses Ø 180 mm (7")	5,50
FSC-200	Metallic clamp for flexible hoses Ø 200 mm (8")	6,50



RUBBER COVER		
Rubber cover for metallic clamps		
Code	Description	Price €
COPRI-FSC-75	Rubber cover for metallic clamps FSC-75	5,50
COPRI-FSC-100	Rubber cover for metallic clamps FSC-100	5,50
COPRI-FSC-125	Rubber cover for metallic clamps FSC-125	10,50
COPRI-FSC-150	Rubber cover for metallic clamps FSC-150	10,50



SUSPENSION FOR HOSE		
Rubber suspension for flexible hose		
Code	Description	Price €
ASZ-75-S	Rubber suspension for flexible hose complete with hook CSZT Ø 75 with balancer (or CSZT-CAT)	30,50
ASZ-100-S	Rubber suspension for flexible hose complete with hook CSZT Ø 100 with balancer (or CSZT-CAT)	30,50
ASZ-125-S	Rubber suspension for flexible hose complete with hook CSZT Ø 125 with balancer (or CSZT-CAT)	30,50
ASZ-150-S	Rubber suspension for flexible hose complete with hook CSZT Ø 150 with balancer (or CSZT-CAT)	30,50





KIT TECHNO + FAN		
Code	Description	Price €
TECHNO-220/100	Articulated arm Ø 150 - L. 2 mt. + Fan AL-100/C - outlet Ø 180-R	1.535,00
TECHNO-220/150	Articulated arm Ø 150 - L. 2 mt. + Fan AL-150/C - outlet Ø 180-R	1.552,00
TECHNO-330/100	Articulated arm Ø 150 - L. 3 mt. + Fan AL-100/C - outlet Ø 180-R	1.548,00
TECHNO-330/150	Articulated arm Ø 150 - L. 3 mt. + Fan AL-150/C - outlet Ø 180-R	1.571,00
TECHNO-330/200	Articulated arm Ø 150 - L. 3 mt. + Fan AL-200/C - outlet Ø 200-R	1.741,00
TECHNO-330/300	Articulated arm Ø 150 - L. 3 mt. + Fan AL-300/C - outlet Ø 200-R	1.813,00
TECHNO-420/100	Articulated arm Ø 150 - L. 4 mt. + Fan AL-100/C - outlet Ø 180-R	1.627,00
TECHNO-420/150	Articulated arm Ø 150 - L. 4 mt. + Fan AL-150/C - outlet Ø 180-R	1.650,00
TECHNO-420/200	Articulated arm Ø 150 - L. 4 mt. + Fan AL-200/C - outlet Ø 200-R	1.820,00
TECHNO-420/300	Articulated arm Ø 150 - L. 4 mt. + Fan AL-300/C - outlet Ø 200-R	1.894,00
TECHNO-520/200	Articulated arm Ø 150 - L. 5 mt. + Fan AL-200/C - outlet Ø 200-R	2.019,00
TECHNO-520/300	Articulated arm Ø 150 - L. 5 mt. + Fan AL-300/C - outlet Ø 200-R	2.093,00



KIT TECHNO + FAN		
Code	Description	Price €
TECHNO-620/200	Articulated arm Ø 150 - L. = 4 mt. + extension L. = 2 mt. + Fan AL-200/C - out Ø 200-R	2.889,00
TECHNO-620/300	Articulated arm Ø 150 - L. = 4 mt. + extension L. = 2 mt. + Fan AL-300/C - out Ø 200-R	2.964,00
TECHNO-720/200	Articulated arm Ø 150 - L. = 4 mt. + extension L. = 3 mt. + Fan AL-200/C - out Ø 200-R	2.953,00
TECHNO-720/300	Articulated arm Ø 150 - L. = 4 mt + extension L. = 3 mt. + Fan AL-300/C - out Ø 200-R	3.028,00
TECHNO-820/200	Articulated arm Ø 150 - L. = 4 mt. + extension L. = 4 mt. + Fan AL-200/C - out Ø 200-R	3.103,00
TECHNO-820/300	Articulated arm Ø 150 - L. = 4 mt. + extension L. = 4 mt. + Fan AL-300/C - out Ø 200-R	3.178,00
TECHNO-920/200	Articulated arm Ø 150 - L. = 4 mt. + extension L. = 5 mt. + Fan AL-200/C - out Ø 200-R	3.331,00
TECHNO-920/300	Articulated arm Ø 150 - L. = 4 mt. + extension L. = 5 mt. + Fan AL-300/C - out Ø 200-R	3.405,00



KIT 2 TECHNO + FAN		
Code	Description	Price €
TECHNO-2-220/300	2 Articulated arms Ø 150 - L. = 2 mt. + Fan AL-300 /C - out Ø 200-R	2.986,00
TECHNO-2-330/300	2 Articulated arms Ø 150 - L. = 3 mt. + Fan AL-300/C - out Ø 200-R	3.025,00
TECHNO-2-420/300	2 Articulated arms Ø 150 - L. = 4 mt. + Fan AL-300/C - out Ø 200-R	3.149,00

KIT TECHNOFLEX + FAN		
Code	Description	Price €
TECHNOFLEX220/100	Articulated arm Ø 160 - L. = 2 mt. + Fan AL-100 - out Ø 180-R	1.463,00
TECHNOFLEX330/100	Articulated arm Ø 160 - L. = 3 mt. + Fan AL-100 - out Ø 180-R	1.497,00
TECHNOFLEX330/150	Articulated arm Ø 160 - L. = 3 mt. + Fan AL-150 - out Ø 180-R	1.519,00
TECHNOFLEX330/200	Articulated arm Ø 160 - L. = 3 mt. + Fan AL-200 - out Ø 200-R	1.701,00
TECHNOFLEX330/300	Articulated arm Ø 160 - L. = 3 mt. + Fan AL-300 - out Ø 200-R	1.790,00
TECHNOFLEX420/100	Articulated arm Ø 160 - L. = 4 mt. + Fan AL-100 - out Ø 180-R	1.543,00
TECHNOFLEX420/150	Articulated arm Ø 160 - L. = 4 mt. + Fan AL-150 - out Ø 180-R	1.565,00
TECHNOFLEX420/200	Articulated arm Ø 160 - L. = 4 mt. + Fan AL-200 - out Ø 200-R	1.758,00
TECHNOFLEX420/300	Articulated arm Ø 160 - L. = 4 mt. + Fan AL-300 - out Ø 200-R	1.826,00



KIT TECHNOFLEX + FAN		
Code	Description	Price €
TECHNOFLEX620/200	Articulated arm Ø 160 - L. = 4 mt. + extension L. = 2 mt. + Fan AL-200 - out Ø 200-R	2.827,00
TECHNOFLEX620/300	Articulated arm Ø 160 - L. = 4 mt. + extension L. = 2 mt. + Fan AL-300 - out Ø 200-R	2.895,00
TECHNOFLEX720/200	Articulated arm Ø 160 - L. = 4 mt. + extension L. = 3 mt. + Fan AL-200 - out Ø 200-R	2.894,00
ECHNOFLEX720/300	Articulated arm Ø 160 - L. = 4 mt. + extension L. = 3 mt. + Fan AL-300 - out Ø 200-R	2.963,00
TECHNOFLEX820/200	Articulated arm Ø 160 - L. = 4 mt. + extension L. = 4 mt. + Fan AL-200 - out Ø 200-R	3.042,00
ECHNOFLEX820/300	Articulated arm Ø 160 - L. = 4 mt. + extension L. = 4 mt. + Fan AL-300 - out Ø 200-R	3.110,00
TECHNOFLEX920/200	Articulated arm Ø 160 - L. = 4 mt. + extension L. = 5 mt. + Fan AL-200 - out Ø 200-R	3.280,00
TECHNOFLEX920/300	Articulated arm Ø 160 - L. = 4 mt. + extension L. = 5 mt. + Fan AL-300 - out Ø 200-R	3.337,00





KIT DUSTY DIAM. 100 + FAN

Extraction kit with articulated arm and fan

Code	Description	Price €
DUSTY-210/50	Articulated arm Ø 100 - L. = 2 mt. + Fan AL-50/C - out Ø 150-R	1.375,00
DUSTY-210/100	Articulated arm Ø 100 - L. = 2 mt. + Fan AL-100/C - out Ø 180-R	1.533,00
DUSTY-270/50	Articulated arm Ø 100 - L. = 2 mt. + Fan AL-50/C - out Ø 150-R	1.386,00
DUSTY-270/100	Articulated arm Ø 100 - L. = 2 mt. + Fan AL-100/C - out Ø 180-R	1.542,00



KIT DUSTY DIAM. 200+ FAN

Extraction kit with articulated arm and fan

Code	Description	Price €
DUSTY-350/200	Articulated arm Ø 200 - L. = 3 mt. + Fan AL-200/C - out Ø 200-R	2.160,00
DUSTY-350/300	Articulated arm Ø 200 - L. = 3 mt. + Fan AL-300/C - out Ø 200-R	2.399,00
DUSTY-470/200	Articulated arm Ø 200 - L. = 4 mt. + Fan AL-200/C - out Ø 200-R	2.301,00
DUSTY-470/300	Articulated arm Ø 200 - L. = 4 mt. + Fan AL-300/C - out Ø 200-R	2.419,00



ASPIRVAPOR-75

Extraction kit for vapours and fumes complete with fiberglass hood, 5 mt. long flexible hose and 0,75 HP extraction fan

Code	Description	Price €
ASPIRVAPOR-75	400V - 50Hz - 3P + T	1.588,00
ASPIRVAPOR-75M	230V - 50Hz - 1P + N + T	1.634,00
ASPIRVAPOR-75A	400V - 50Hz - 3P + T (spark proof fan)	2.359,00
Code	Spare parts	Price €
AK-75	Fan in/out Ø 120-L	860,00
C.VR1000X1200	Fiberglass hood dim. 1000 x 1200 x h300	481,50
ASPIRFLEX-120	Flexible hose 5 mt. long Ø 120 mm (Price per meter)	€/mt. 22,50

KIT TECHNOSTAR-2000

Extraction and filtration kit composed by an arm TECHNO directly connected with a fan and a mechanical filter model STARFILTER-2000

Code	Description	Price €
TECHNOSTAR-2000/2	Kit composed by a filter STAR-2000 and TECHNO-220/200	3.030,00
TECHNOSTAR-2000/3	Kit composed by a filter STAR-2000 and TECHNO-330/200	3.129,00
TECHNOSTAR-2000/4	Kit composed by a filter STAR-2000 and TECHNO-420/200	3.328,00
Code	Accessories	Price €
STAR-2000-FU	Filter outlet flange for centralized expulsion to Ø 200/R	147,00
STAR-2000-SPS	2 Wall fixing supports	55,00



KIT TECHNOSTAR-4000

Extraction and filtration kit composed by an arm TECHNO directly connected with a fan and a mechanical filter model STARFILTER-4000

Code	Description	Price €
TECHNOSTAR-4000/2	Kit composed by a filter STAR-4000 and TECHNO-220/200	3.559,00
TECHNOSTAR-4000/3	Kit composed by a filter STAR-4000 and TECHNO-330/200	3.657,00
TECHNOSTAR-4000/4	Kit composed by a filter STAR-4000 and TECHNO-420/200	3.820,00
Code	Accessories	Price €
STAR-4000-FU	Filter outlet flange for centralized expulsion to Ø 200/R	203,00
STAR-4000-SPS	2 Wall fixing supports	62,00



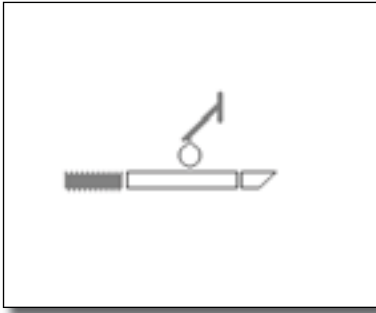

CHIMNEY KIT-01

Expulsion chimney set for filcar extraction kits. Version approx 2 mt. long. Example: the CAMINO-01-150 is composed by:

1 pz. TU-150-1.5	1 pz. ST-CL-150
1 pz. ALLUFLEX-150	1 pz. CL-150
2 pz. FSC-150	1 pz. TEG-150

Code	Description	Price €
CAMINO-01-150	To be connected to fan of 0,5 HP	190,00
CAMINO-01-180	To be connected to fan of 1 and 1,5 HP	206,00
CAMINO-01-200	To be connected to fan of 2 and 3 HP	218,00

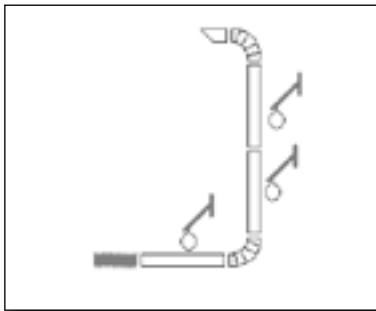

KIT CAMINO-02

Expulsion chimney set for filcar extraction kits. Version approx 5 mt. long. Example: the CAMINO-02-150 is composed by:

3 pz. TU-150-1.5	3 pz. ST-CL-150
1 pz. ALLUFLEX-150	5 pz. CL-150
2 pz. CR-150-90	1 pz. TEG-150
2 pz. FSC-150	

Code	Description	Price €
CAMINO-02-150	To be connected to fan of 0,5 HP	475,00
CAMINO-02-180	To be connected to fan of 1 and 1,5 HP	523,00
CAMINO-02-200	To be connected to fan of 2 and 3 HP	550,00

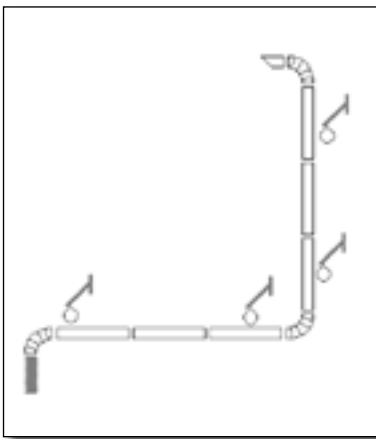

KIT CAMINO-03

Expulsion chimney set for filcar extraction kits. Version approx 10 mt. long. Example: the CAMINO-03-180 is composed by:

6 pz. TU-180-1.5	6 pz. ST-CL-180-L
1 pz. ALLUFLEX-180	9 pz. CL-180
3 pz. CR-180-90	1 pz. TEG-180
2 pz. FSC-180	

Code	Description	Price €
CAMINO-03-150	To be connected to fan of 0,5 HP	950,00
CAMINO-03-180	To be connected to fan of 1 and 1,5 HP	1.020,00
CAMINO-03-200	To be connected to fan of 2 and 3 HP	1.060,00

AFON		
Circular silencer to be placed after the fan		
Code	Description	Price €
AFON-120-1	Silencer Ø 120 mm - L. 1 mt. noise reduction ~ 3 dB	273,00
AFON-150-1	Silencer Ø 150 mm - L. 1 mt. noise reduction ~ 3 dB	279,50
AFON-180-1	Silencer Ø 180 mm - L. 1 mt. noise reduction ~ 3 dB	290,00
AFON-200-1	Silencer Ø 200 mm - L. 1 mt. noise reduction ~ 3 dB	297,50
AFON-220-1	Silencer Ø 220 mm - L. 1 mt. noise reduction ~ 3 dB	308,00
AFON-250-1	Silencer Ø 250 mm - L. 1 mt. noise reduction ~ 3 dB	357,00
AFON-280-1	Silencer Ø 280 mm - L. 1 mt. noise reduction ~ 3 dB	384,50
AFON-300-1	Silencer Ø 300 mm - L. 1 mt. noise reduction ~ 3 dB	408,50
AFON-350-1	Silencer Ø 350 mm - L. 1 mt. noise reduction ~ 3 dB	458,00
AFON-380-1	Silencer Ø 380 mm - L. 1 mt. noise reduction ~ 3 dB	479,00
AFON-400-1	Silencer Ø 400 mm - L. 1 mt. noise reduction ~ 3 dB	479,00

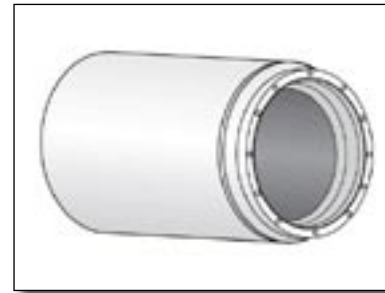

TU		
Ducting section 1,5 mt long with lip for collars		
Code	Description	Price €
TU-80-1,5	Ducting section Ø 80 mm - L. 1,5 mt.	37,00
TU-100-1,5	Ducting section Ø 100 mm - L. 1,5 mt.	40,00
TU-120-1,5	Ducting section Ø 120 mm - L. 1,5 mt.	43,50
TU-150-1,5	Ducting section Ø 150 mm - L. 1,5 mt.	48,50
TU-180-1,5	Ducting section Ø 180 mm - L. 1,5 mt.	54,00
TU-200-1,5	Ducting section Ø 200 mm - L. 1,5 mt.	56,00
TU-220-1,5	Ducting section Ø 220 mm - L. 1,5 mt.	63,00
TU-250-1,5	Ducting section Ø 250 mm - L. 1,5 mt.	69,50
TU-280-1,5	Ducting section Ø 280 mm - L. 1,5 mt.	70,50
TU-300-1,5	Ducting section Ø 300 mm - L. 1,5 mt.	71,50
TU-320-1,5	Ducting section Ø 320 mm - L. 1,5 mt.	76,00
TU-350-1,5	Ducting section Ø 350 mm - L. 1,5 mt.	77,00
TU-380-1,5	Ducting section Ø 380 mm - L. 1,5 mt.	85,50
TU-400-1,5	Ducting section Ø 400 mm - L. 1,5 mt.	90,50



TU-USL		
Ducting section 1,5 mt long with lip for collars and inspection opening		
Code	Description	Price €
TU-150-1,5USL	Ducting section Ø 150 mm - L. 1,5 mt. with inspection opening	207,00
TU-180-1,5USL	Ducting section Ø 180 mm - L. 1,5 mt. with inspection opening	214,50
TU-200-1,5USL	Ducting section Ø 200 mm - L. 1,5 mt. with inspection opening	215,50
TU-220-1,5USL	Ducting section Ø 220 mm - L. 1,5 mt. with inspection opening	224,00
TU-250-1,5USL	Ducting section Ø 250 mm - L. 1,5 mt. with inspection opening	230,00
TU-280-1,5USL	Ducting section Ø 280 mm - L. 1,5 mt. with inspection opening	231,00
TU-300-1,5USL	Ducting section Ø 300 mm - L. 1,5 mt. with inspection opening	232,50
TU-320-1,5USL	Ducting section Ø 320 mm - L. 1,5 mt. with inspection opening	234,50
TU-350-1,5USL	Ducting section Ø 350 mm - L. 1,5 mt. with inspection opening	235,50
TU-380-1,5USL	Ducting section Ø 380 mm - L. 1,5 mt. with inspection opening	237,50
TU-400-1,5USL	Ducting section Ø 400 mm - L. 1,5 mt. with inspection opening	243,00

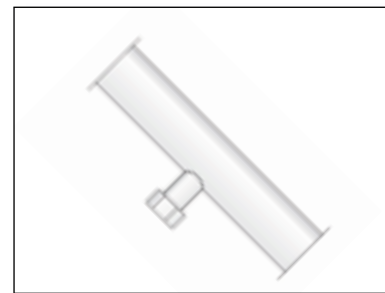

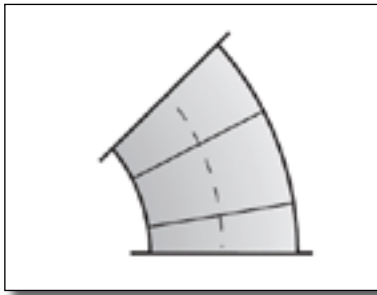

CR - 45		
Metal sheet bend 45° with lip for collars		
Code	Description	Price €
CR-100-45	Metal sheet bend Ø 100 mm - 45°	23,50
CR-120-45	Metal sheet bend Ø 120 mm - 45°	24,50
CR-150-45	Metal sheet bend Ø 150 mm - 45°	26,50
CR-180-45	Metal sheet bend Ø 180 mm - 45°	36,00
CR-200-45	Metal sheet bend Ø 200 mm - 45°	37,00
CR-220-45	Metal sheet bend Ø 220 mm - 45°	41,00
CR-250-45	Metal sheet bend Ø 250 mm - 45°	47,50
CR-280-45	Metal sheet bend Ø 280 mm - 45°	49,50
CR-300-45	Metal sheet bend Ø 300 mm - 45°	54,00
CR-320-45	Metal sheet bend Ø 320 mm - 45°	56,00
CR-350-45	Metal sheet bend Ø 350 mm - 45°	60,00
CR-380-45	Metal sheet bend Ø 380 mm - 45°	66,50
CR-400-45	Metal sheet bend Ø 400 mm - 45°	70,50

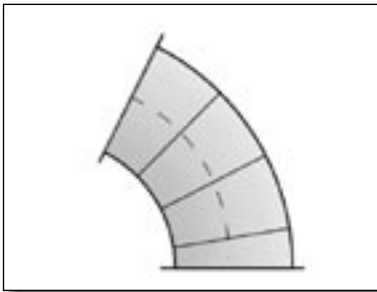

CR - 75		
Metal sheet bend 75° with lip for collars		
Code	Description	Price €
CR-100-75	Metal sheet bend Ø 100 mm - 75°	38,00
CR-120-75	Metal sheet bend Ø 120 mm - 75°	42,00
CR-150-75	Metal sheet bend Ø 150 mm - 75°	50,50
CR-180-75	Metal sheet bend Ø 180 mm - 75°	55,00
CR-200-75	Metal sheet bend Ø 200 mm - 75°	63,00
CR-220-75	Metal sheet bend Ø 220 mm - 75°	69,50
CR-250-75	Metal sheet bend Ø 250 mm - 75°	75,00
CR-280-75	Metal sheet bend Ø 280 mm - 75°	80,00
CR-300-75	Metal sheet bend Ø 300 mm - 75°	87,50
CR-320-75	Metal sheet bend Ø 320 mm - 75°	94,50
CR-350-75	Metal sheet bend Ø 350 mm - 75°	101,00
CR-380-75	Metal sheet bend Ø 380 mm - 75°	113,50
CR-400-75	Metal sheet bend Ø 400 mm - 75°	123,00

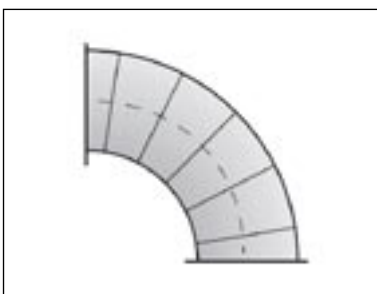

CR - 90		
Metal sheet bend 90° with lip for collars		
Code	Description	Price €
CR-100-90	Metal sheet bend Ø 100 mm - 90°	47,50
CR-120-90	Metal sheet bend Ø 120 mm - 90°	52,50
CR-150-90	Metal sheet bend Ø 150 mm - 90°	58,00
CR-180-90	Metal sheet bend Ø 180 mm - 90°	68,50
CR-200-90	Metal sheet bend Ø 200 mm - 90°	75,00
CR-220-90	Metal sheet bend Ø 220 mm - 90°	81,00
CR-250-90	Metal sheet bend Ø 250 mm - 90°	93,50
CR-280-90	Metal sheet bend Ø 280 mm - 90°	94,50
CR-300-90	Metal sheet bend Ø 300 mm - 90°	106,50
CR-320-90	Metal sheet bend Ø 320 mm - 90°	111,50
CR-350-90	Metal sheet bend Ø 350 mm - 90°	120,00
CR-380-90	Metal sheet bend Ø 380 mm - 90°	131,50
CR-400-90	Metal sheet bend Ø 400 mm - 90°	141,00

DE-2 SYMMETRICAL

Symmetrical deviation with lip for collars. Please specify Ø B and Ø C when ordering

Code	Description	Price €
DE-2-S100	Symmetrical deviation Ø 100 mm	122,00
DE-2-S120	Symmetrical deviation Ø 120 mm	126,00
DE-2-S150	Symmetrical deviation Ø 150 mm	129,50
DE-2-S180	Symmetrical deviation Ø 180 mm	138,00
DE-2-S200	Symmetrical deviation Ø 200 mm	150,50
DE-2-S220	Symmetrical deviation Ø 220 mm	153,50
DE-2-S250	Symmetrical deviation Ø 250 mm	159,00
DE-2-S280	Symmetrical deviation Ø 280 mm	172,50
DE-2-S300	Symmetrical deviation Ø 300 mm	184,00
DE-2-S320	Symmetrical deviation Ø 320 mm	189,00
DE-2-S350	Symmetrical deviation Ø 350 mm	195,50
DE-2-S380	Symmetrical deviation Ø 380 mm	201,00
DE-2-S400	Symmetrical deviation Ø 400 mm	211,50

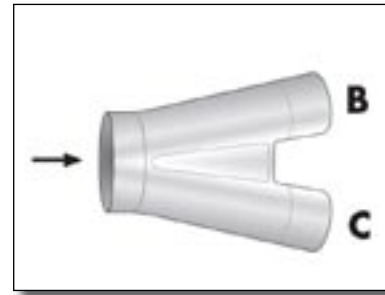

DE-2 ASYMMETRICAL

Asymmetrical deviation with lip for collars. Please specify Ø B and Ø C when ordering

Code	Description	Price €
DE-2-A100	Asymmetrical deviation Ø 100 mm	122,00
DE-2-A120	Asymmetrical deviation Ø 120 mm	126,00
DE-2-A150	Asymmetrical deviation Ø 150 mm	129,50
DE-2-A180	Asymmetrical deviation Ø 180 mm	138,00
DE-2-A200	Asymmetrical deviation Ø 200 mm	150,50
DE-2-A220	Asymmetrical deviation Ø 220 mm	153,50
DE-2-A250	Asymmetrical deviation Ø 250 mm	159,00
DE-2-A280	Asymmetrical deviation Ø 280 mm	172,50
DE-2-A300	Asymmetrical deviation Ø 300 mm	184,00
DE-2-A320	Asymmetrical deviation Ø 320 mm	189,00
DE-2-A350	Asymmetrical deviation Ø 350 mm	195,50
DE-2-A380	Asymmetrical deviation Ø 380 mm	201,00
DE-2-A400	Asymmetrical deviation Ø 400 mm	211,50

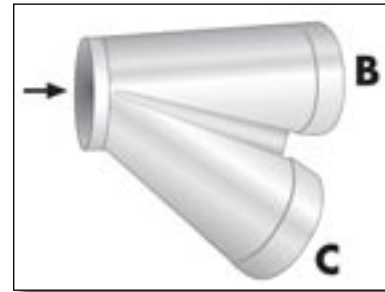

GNT

Vibration suppressing junction for fans

Code	Description	Price €
GNT-100	Vibration suppressing junction Ø 100 mm	67,50
GNT-120	Vibration suppressing junction Ø 120 mm	67,50
GNT-150	Vibration suppressing junction Ø 150 mm	67,50
GNT-180	Vibration suppressing junction Ø 180 mm	69,50
GNT-200	Vibration suppressing junction Ø 200 mm	69,50
GNT-220	Vibration suppressing junction Ø 220 mm	70,50
GNT-250	Vibration suppressing junction Ø 250 mm	71,50
GNT-280	Vibration suppressing junction Ø 280 mm	73,50
GNT-300	Vibration suppressing junction Ø 300 mm	76,00
GNT-320	Vibration suppressing junction Ø 320 mm	89,50
GNT-350	Vibration suppressing junction Ø 350 mm	89,50
GNT-380	Vibration suppressing junction Ø 380 mm	100,00
GNT-400	Vibration suppressing junction Ø 400 mm	106,50



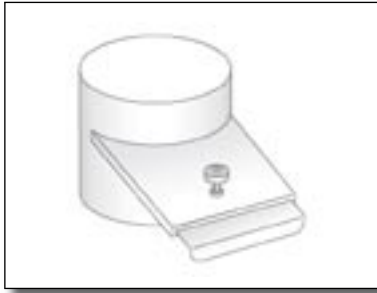

SER		
Gate valve with lip for collars		
Code	Description	Price €
SER-100	Gate valve Ø 100 mm	31,50
SER-120	Gate valve Ø 120 mm	33,00
SER-150	Gate valve Ø 150 mm	35,00
SER-180	Gate valve Ø 180 mm	37,00
SER-200	Gate valve Ø 200 mm	39,00
SER-220	Gate valve Ø 220 mm	56,00
SER-250	Gate valve Ø 250 mm	67,50
SER-280	Gate valve Ø 280 mm	123,00
SER-300	Gate valve Ø 300 mm	145,00
SER-320	Gate valve Ø 320 mm	150,50
SER-350	Gate valve Ø 350 mm	155,50
SER-380	Gate valve Ø 380 mm	178,50
SER-400	Gate valve Ø 400 mm	245,00

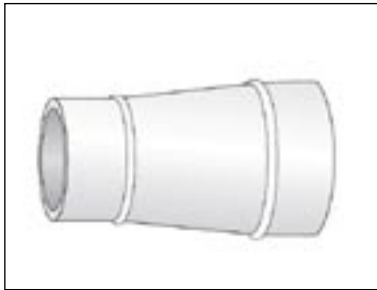

CO		
Metal sheet reduction cone with lip for collars: please specify smaller diameter when ordering		
Code	Description	Price €
CO-80	Reduction cone Ø 80 mm	39,00
CO-100	Reduction cone Ø 100 mm	39,00
CO-120	Reduction cone Ø 120 mm	44,50
CO-150	Reduction cone Ø 150 mm	50,50
CO-180	Reduction cone Ø 180 mm	54,00
CO-200	Reduction cone Ø 200 mm	58,00
CO-220	Reduction cone Ø 220 mm	62,00
CO-250	Reduction cone Ø 250 mm	63,00
CO-280	Reduction cone Ø 280 mm	68,50
CO-300	Reduction cone Ø 300 mm	78,00
CO-320	Reduction cone Ø 320 mm	84,00
CO-350	Reduction cone Ø 350 mm	100,00

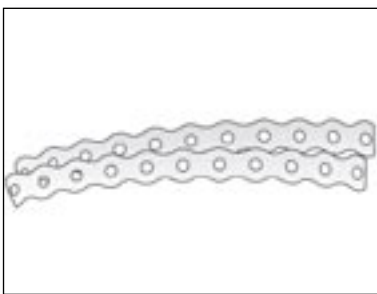

REGGIA		
Metal band for duct support		
Code	Description	Price €
REGGIA	Metal band for duct support (price per meter)	€/mt 4,50

CP		
Expulsion chimney "chinese cap" with lip for collars		
Code	Description	Price €
CP-100	Chimney Ø 100 mm	94,50
CP-120	Chimney Ø 120 mm	101,00
CP-150	Chimney Ø 150 mm	111,50
CP-180	Chimney Ø 180 mm	122,00
CP-200	Chimney Ø 200 mm	130,50
CP-220	Chimney Ø 220 mm	136,50
CP-250	Chimney Ø 250 mm	144,00
CP-280	Chimney Ø 280 mm	165,00
CP-300	Chimney Ø 300 mm	174,50
CP-320	Chimney Ø 320 mm	196,50
CP-350	Chimney Ø 350 mm	214,50
CP-380	Chimney Ø 380 mm	228,00
CP-400	Chimney Ø 400 mm	235,50



TEG		
Horizontal expulsion chimney with lip for collars and protection net		
Code	Description	Price €
TEG-100	Ø 100	58,00
TEG-120	Ø 120	58,00
TEG-150	Ø 150	61,00
TEG-180	Ø 180	66,50
TEG-200	Ø 200	68,50
TEG-220	Ø 220	71,50
TEG-250	Ø 250	78,00
TEG-280	Ø 280	78,00
TEG-300	Ø 300	78,00
TEG-320	Ø 320	78,00
TEG-350	Ø 350	80,00
TEG-380	Ø 380	92,50
TEG-400	Ø 400	98,00



CL		
Joining collars for ducting sections		
Code	Description	Price €
CL-100	Collar Ø 100 mm	4,50
CL-120	Collar Ø 120 mm	4,50
CL-150	Collar Ø 150 mm	5,50
CL-180	Collar Ø 180 mm	5,50
CL-200	Collar Ø 200 mm	5,50
CL-220	Collar Ø 220 mm	7,50
CL-250	Collar Ø 250 mm	7,50
CL-280	Collar Ø 280 mm	8,50
CL-300	Collar Ø 300 mm	8,50
CL-320	Collar Ø 320 mm	9,50
CL-350	Collar Ø 350 mm	10,50
CL-380	Collar Ø 380 mm	12,00
CL-400	Collar Ø 400 mm	13,00





ST-CL		
Wall fixing collars for ducting sections and bracket 300 mm long		
Code	Description	Price €
ST-CL100	Wall fixing collar Ø 100 mm	41,00
ST-CL120	Wall fixing collar Ø 120 mm	41,00
ST-CL150	Wall fixing collar Ø 150 mm	43,00
ST-CL180	Wall fixing collar Ø 180 mm	44,00
ST-CL200	Wall fixing collar Ø 200 mm	44,00
ST-CL220	Wall fixing collar Ø 220 mm	44,00
ST-CL250	Wall fixing collar Ø 250 mm	44,50
ST-CL280	Wall fixing collar Ø 280 mm	44,50
ST-CL300	Wall fixing collar Ø 300 mm	44,50
ST-CL320	Wall fixing collar Ø 320 mm	44,50
ST-CL350	Wall fixing collar Ø 350 mm	47,50
ST-CL380	Wall fixing collar Ø 380 mm	48,50
ST-CL400	Wall fixing collar Ø 400 mm	48,50

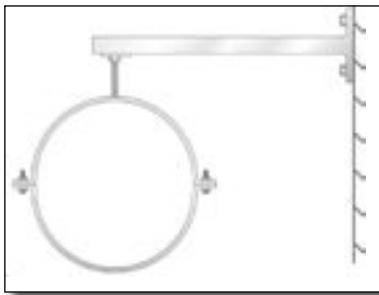

ST-CL-L		
Wall fixing collars for ducting sections and bracket 750 mm long		
Code	Description	Price €
ST-CL100-L	Wall fixing collar for Ø 100 mm with bracket 750 mm long	71,00
ST-CL120-L	Wall fixing collar for Ø 120 mm with bracket 750 mm long	71,00
ST-CL150-L	Wall fixing collar for Ø 150 mm with bracket 750 mm long	71,00
ST-CL180-L	Wall fixing collar for Ø 180 mm with bracket 750 mm long	71,00
ST-CL200-L	Wall fixing collar for Ø 200 mm with bracket 750 mm long	71,00
ST-CL220-L	Wall fixing collar for Ø 220 mm with bracket 750 mm long	71,00
ST-CL250-L	Wall fixing collar for Ø 250 mm with bracket 750 mm long	72,00
ST-CL280-L	Wall fixing collar for Ø 280 mm with bracket 750 mm long	72,00
ST-CL300-L	Wall fixing collar for Ø 750 mm with bracket 750 mm long	73,00
ST-CL320-L	Wall fixing collar for Ø 320 mm with bracket 750 mm long	73,50
ST-CL350-L	Wall fixing collar for Ø 350 mm with bracket 750 mm long	73,50
ST-CL380-L	Wall fixing collar for Ø 380 mm with bracket 750 mm long	73,50
ST-CL400-L	Wall fixing collar for Ø 400 mm with bracket 750 mm long	77,00

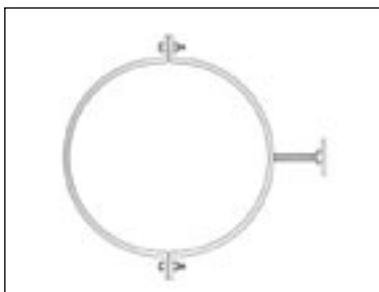

CA-CL		
Wall fixing collars for ducting sections		
Code	Description	Price €
CA-CL100	Ø 100	8,50
CA-CL120	Ø 120	8,50
CA-CL150	Ø 150	8,50
CA-CL180	Ø 180	9,50
CA-CL200	Ø 200	10,00
CA-CL220	Ø 220	11,00
CA-CL250	Ø 250	12,00
CA-CL280	Ø 280	12,00
CA-CL300	Ø 300	13,00
CA-CL320	Ø 320	13,00
CA-CL350	Ø 350	14,00
CA-CL400	Ø 400	16,00

SALES CONDITIONS

1. PRICE AND TERMS OF PAYMENT

1.1 The prices written in this price list don't include VAT, packing / forwarding charges or any other charge that has not been clearly pointed out in sales contracts or that doesn't pertain to FILCAR by law.

1.2 All payments are to be made at Filcar's premises even in case of payment by draft or promissory note.

1.3 In case of terms of payment longer than the agreed ones, the Company FILCAR has the right to ask for interests reckoned on the highest "Prime Rate" agreed by the National Interest Bank (BIN) on the date of payment plus 5% (five for cent).

1.4 No set-off is accepted. Payments cannot be delayed or suspended even in case of disputes, claims or delays by FILCAR.

2. DELIVERY

2.1 The goods are sold ex-works at FILCAR premises, packing excluded, unless otherwise clearly stated. Even in case of goods delivered free Buyer's warehouse, delivery is considered as effected at FILCAR premises. The Buyer always takes upon himself all transport risks.

2.2 The delivery date is merely approximate and cannot be held as confirmed. Partial shipments are allowed. Any possible compensation for direct and indirect damages due to delayed deliveries won't be accepted.

2.3 If FILCAR executes orders only in part or postpones deliveries due to uncontrollable events, including strikes, breakdowns of production equipments or other problems for which a third-party is to be blamed, the Buyer has no right to claim for damages.

3. CLAIMS AND WARRANTY

3.1 At receipt of good, the Buyer must check them and notify in writing on the delivery document any possible damage caused by transport or if there are missing articles. The Buyer loses his right to the warranty if he does not notify in writing to FILCAR any vice and or fault not later than 6 days after receipt of goods.

3.2 FILCAR guarantees its products against manufacture defaults for a period of 12 MONTHS after the date of delivery. The Buyer loses his right to the warranty if the engine has not been correctly connected. Any possible part to be replaced or repaired has to be sent to FILCAR transport paid. The transport charges for the sending of replaced or repaired parts will be to the Buyer's account.

3.3 FILCAR reserves the right to modify the technical features of its products without prior notice.

4. RETURNS

4.1 Returns are not accepted, unless they have been agreed on in advance by FILCAR, who will in any case reckon a 15% cut on the net value of the goods.

5. VOLTAGE

5.1 All systems are 400v three-phase 50Hz, unless otherwise stated. Please contact our Sales Department for different tensions or voltage

6. PLACE OF JURISDICTION

6.1 Wherever contracts have been drawn up and even if payment is by draft, the place of jurisdiction for possible dispute is always Reggio Emilia (ITALY)

FILCAR S.p.A. is certified ISO 9001:2000

FILCAR S.p.A.

via G. Balla, 18
42100 - CELLA
REGGIO EMILIA

ITALY

Tel. +39-0522-941881
Fax. +39-0522-942291
Tel. +39-0522-941167
Fax. +39-0522-494035
www.filcar.eu
filcar@filcar.it

FILCAR S.A.R.L.

75, Rue de Malacombe
38070 - ST. QUENTIN
FALLAVIER - LYON

FRANCE

Tel. +33-0474-944064
Fax. +33-0474-942931
www.filcar.eu
contact@filcar.fr

FILCAR Engineering S.L.

Calle Oriente, 7
28690 BRUNETE - MADRID

ESPAÑA

Tel. +34-91-8163127
Fax. +34-91-8132893
www.filcar.eu
filcar@filcar.es

FILCAR G.m.b.H.

FRANKFURT

DEUTSCHLAND

Tel. +49-175-9326142
www.filcar.eu
filcar@filcar.de

FILCAR G.S. S.r.l.

via F.lli Cervi, 169/S
42100 - REGGIO EMILIA

ITALY

Tel. +39-0522-545619
Fax. +39-0522-945352
www.filcar.eu
globalsolution@filcar.it